

GS023

GENIUS SERIES SOFT-MOUNT WASHER-EXTRACTOR

ARCHITECTURAL/MECHANICAL
PRODUCT SPECIFICATIONS

Capacity <i>lbs</i>	25
Cylinder Diameter <i>inch</i>	21.1
Cylinder Depth <i>inch</i>	5
Cylinder Volume <i>cu ft</i>	3
Net Weight <i>lbs</i>	377
Crated Weight <i>lbs</i>	43
Machine Dimensions <i>inch</i> WxDxH	27 x 31.6 x 46.3
Door Opening <i>inch</i>	14.8
Floor to Door <i>inch</i>	15.5
Shipping Dimensions <i>inch</i> WxDxH	28.3 x 34.3 x 52.2
Washing Speed <i>rpm</i>	52
Spin Speed <i>rpm</i>	1154
G-force	400
Static Force Transmitted <i>lbs</i>	472
Dynamic Force Transmitted <i>lbs</i>	141
Frequency of Dynamic Force <i>Hz</i>	19.3
Available Voltages/Wire Conductor/Amp	
Hot Water	120/60/1, 2W+G, 15
Hot Water	208-240/60/1, 2W+G, 15
Electric Auxiliary Heat	208-240/60/1, 2W+G, 30
Electric Auxiliary Heat	208-240/60/3, 3W+G, 20
Drain Diameter <i>inch</i>	3
Water Inlets <i>inch</i>	3/4
Recommended Water Pressure <i>PSI</i>	29-87
Water Flow <i>gal/min</i>	16
Total Power <i>kW</i>	0.7

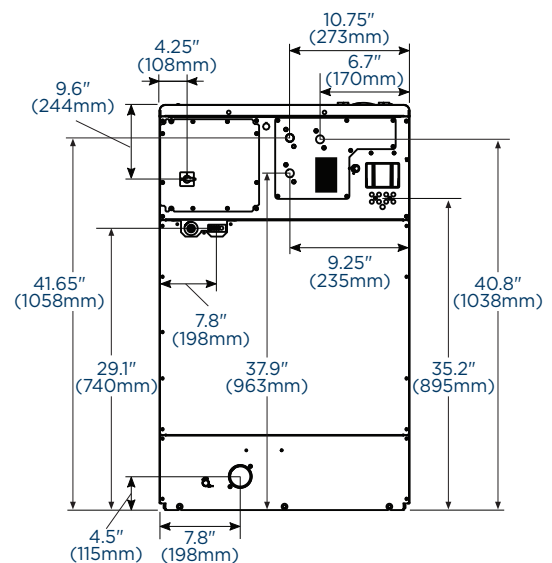
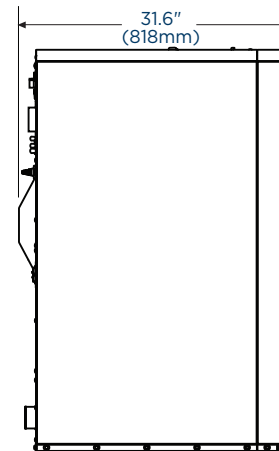
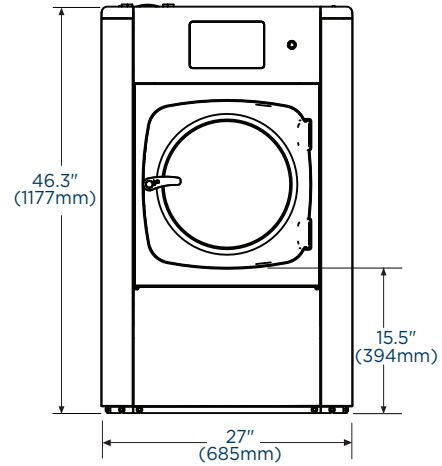

* Specifications subject to change without notice or obligation. Contact Continental Girbau at (800) 256-1073 for dimensions not shown or for clarification.

continentalgirbau.com • (800) 256-1073
2500 State Road 44 • Oshkosh, WI 54904

CONTINENTAL
GIRBAU®